

T-fun

User Manual



NC35

English

○-----○ 1-17



User Manual

Safety instructions

Hearing safety:

- 1.Headphones can't be used during charging for your safety.
- 2.DON'T use the headphones for any other purpose while driving.
- 3.Please use cautiously and stop using headphone in dangerous situation.
- 4.Please do not listen for a long time at high volume to avoid hearing damage.
- 5.For your safety,please do not turn the volume too high while running outside to ensure that you can hear sound in your surroundings.
- 6.Clean only with a dry cloth.

Operation Safety:

- 1.Use original or certified cables for charging and voltage within 6.3V.Power will be cut off and start protection mode when the voltage exceed 6.3V and within 36V.Headphone will be broken when the voltage over 36V.
- 2.Keep away from children to avoid danger from improper use.
- 3.Headphones can't be charged or turned on in the extreme temperature. Please use headphones within the operating temperature range: 32° F (0°C) – 113° F (45°C).
- 4.Do not submerge headphone in the water.
- 5.Do not use corrosive cleaner/oil to clean headphone
- 6.Turn off headphone Bluetooth and ANC function to save power when you do not use headphone.

What's in the Box



NC35 Headphone *1



3.5mm to 6.35mm
Piano Adaptor *1



Portable Carry Case *1

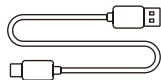

Type-C Charging Cable *1



Audio Cable *1

At a Glance

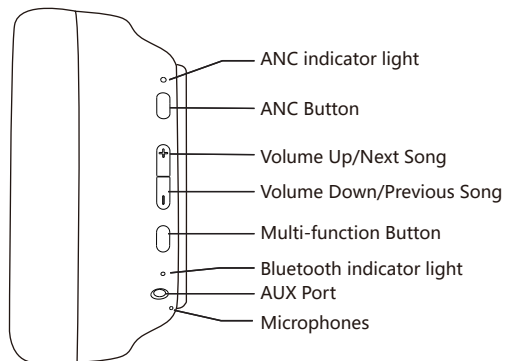
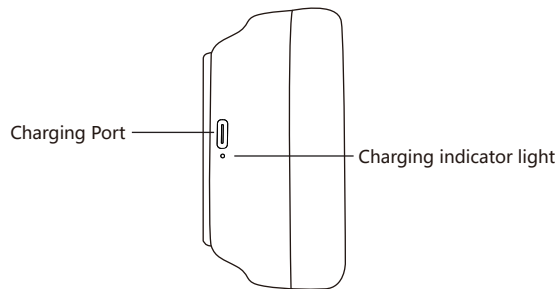

How to Use

Use ANC Function



To turn on ANC, press the ANC Button when Bluetooth turned on; Long press 3 seconds the ANC Button when BT turned off;
(the LED indicator light will be green when ANC ON)
To turn off ANC, press the ANC Button;
(the LED indicator light green color will be off when ANC OFF)

Use Transparency Function



Press the ANC button to switch between ANC mode, Transparency mode and Normal mode.

Use BT Function



3-5S

1. Hold the Multi-function Button for 3-5 seconds to turn headphone Bluetooth on then enter pairing mode. (the LED indicator light will be blue and red flashing quickly.)
2. Start your mobile phone Bluetooth and find headphone Bluetooth pairing name "T-fun NC35" to click it to pair. (the LED indicator light will be blue flashing slowly after pairing successfully.)
3. Hold the Multi-function Button for 3-5 seconds to turn headphone Bluetooth off.
Note: If NC35 is not paired with any devices within 5 minutes after Bluetooth turned on, it will automatically shut down to save power.



Press to adjust volume. Long press to skip to next/previous song.



Press the Multi-function Button to play/pause music or answer/end call.



Double-press the Multi-function Button to activate voice dialing function.



Long press the Multi-function Button to reject an incoming call.

Spatial Audio/Low Latency Mode/ Music Mode



Double press the ANC button to switch between Spatial Audio, Low Latency Game Mode, Music Mode

Function Details

Easy Pairing

1. Hold the Multi-function Button for 3-5 seconds to turn headphone Bluetooth on, then enter pairing mode. (the LED indicator light will be blue and red flashing quickly.)
2. Keep headphone and your mobile phone as close as possible during pairing process.
3. Turn on your mobile phone Bluetooth. Search for headphone Bluetooth signal on mobile phone and click "T-fun NC35" to pair. (the LED indicator light will be blue flashing slowly after pairing successfully.)
4. If you are asked for a password/PiN code during pairing procedure, please enter "0000" (four zeros).

Pair to the Second Bluetooth Device

Step 1: Pair NC35 with First device via Bluetooth successfully and then turn off the First device's Bluetooth.
Step 2: Pair NC35 with the Second device via Bluetooth.
Step 3: Turn on Bluetooth of the first device and pair it with headphone again.
Now both of your devices are paired with NC35 for easy switching.

Active Noise Canceling(ANC) Mode

To turn on ANC, press the ANC Button when Bluetooth turned on; Long press 3 seconds the ANC Button when Bluetooth turned off;

(the LED indicator light will be green when ANC ON)

To turn off ANC, press the ANC Button;

(the LED indicator light green color will be off when ANC OFF)

Transparency Mode

Press the ANC button to switch between ANC mode, Normal mode and Transparency mode

Wired Mode

Headphone support AUX input for wired external audio source connection. Simply turn headphone Bluetooth off and plug in the audio cable.

ANC works in both Bluetooth and Wired mode, But Microphone/Buttons Control work in Bluetooth mode only, not for wired mode.

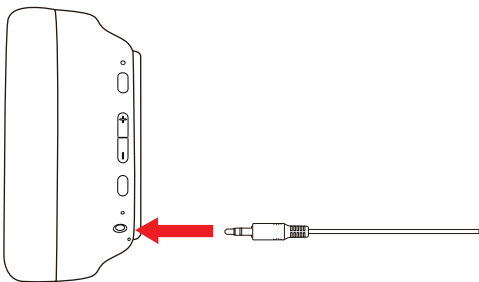

7

Voice Dialing

Press the Mu lti-function Button 2 times to activate voice dialing function(compatible with iPhone Siri and selected Android voice dialing software)

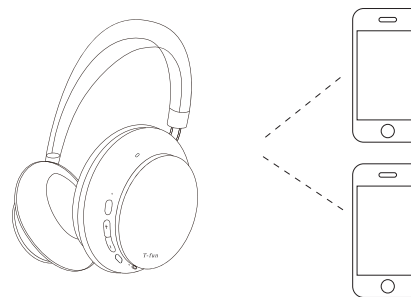

How to Wear

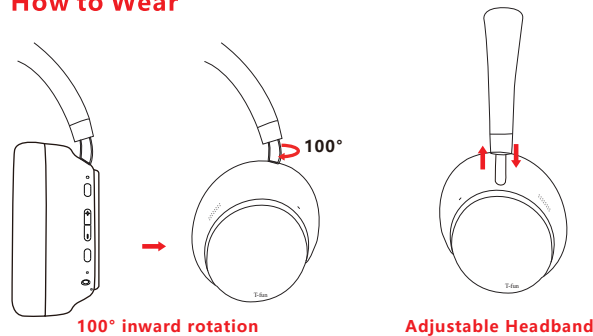

8

Airplane Adaptor Connection

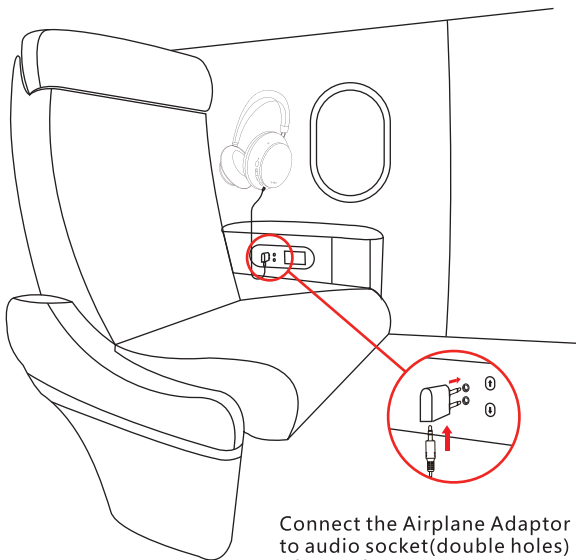

Connect the Airplane Adaptor to audio socket(double holes) of aircraft seat,use 3.5mm audio cable to connect with your headphone and Airplane Adaptor.

Headphone Specification

LED Indicator Light

- Pairing: Blue and red lights flash alternately
 - Paired: Blue light flashes
 - Playing: Blue light slowly flashes
 - Charging: Red light turns on
 - Full Charge: Red light turns off or Blue light turns on
 - Battery Low: Red light turns on with voice prompt
 - ANC ON: Green light turns on
 - ANC OFF: Green light turns off
 - Transparency mode: Green light turns on
 - Bluetooth OFF: Blue and red lights turn off
- * Please kindly note that perhaps sometimes these LED indicator light color will be mixed to become other colors(pink,purple,etc.) occasionally.

Technical Specification

- **Battery capacity:** 700mAh
- **Input:** 5V/1A
- **Chip:** JL7018 V5.3
- **Charging time:** About 2.5 hours
- **Use time:** 55Hrs (60% Volume/ANC on)
- **Bluetooth profile:** A2DP, AVRCP, HSP, HFP
- **Bluetooth range:** 15m/50ft
- **Waterproof rating:** IPX4
- **Net weight:** 230g/0.5lb
- **Impedance:** 32 Ω
- **Driver diameter:** Φ 40mm
- **Frequency response:** 20-20KHz

If your headphone has no sound or the microphone is not working

Please make sure that the headphone is connected before starting software

Sistema macOS

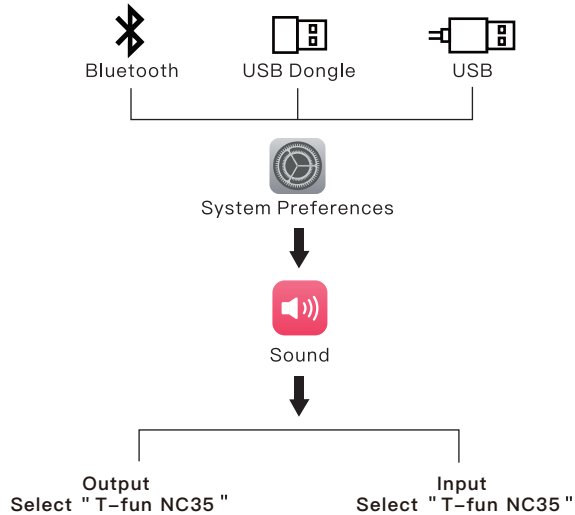

Sistema Windows

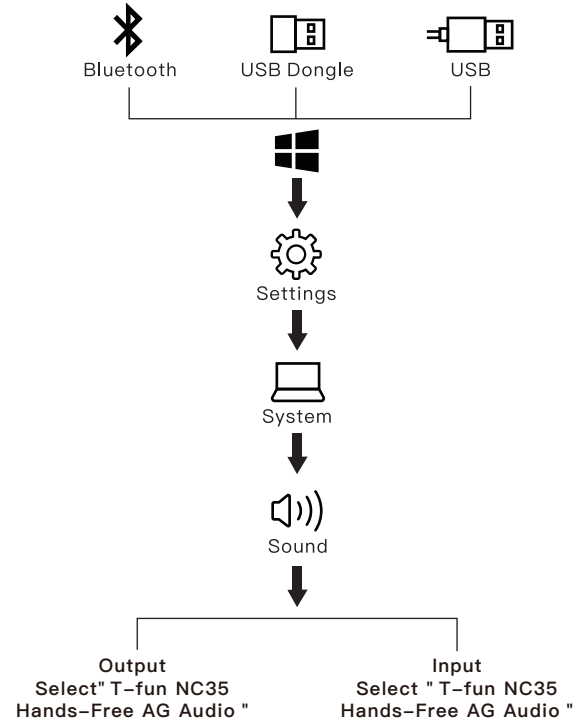

Charging

Use the included Type-C charging cable to connect to head phone Charging Port. Connect the other end of charging cable to a computer USB port or USB wall charger under 6.3V voltage. Turn off head phone Bluetooth and ANC function before charging. Headphone can't be used while charging for your safety. The LED indicator light will be off or blue color when full of charge basing on headphone turn off status. Start your mobile phone Bluetooth and find headphone Bluetooth pairing name " T-fun NC35" to click it to pair. (the LED indicator light will be blue flashing slowly after pairing successfully.) Hold the Multi-function Button for 3-5 seconds to turn headphone Bluetooth off.

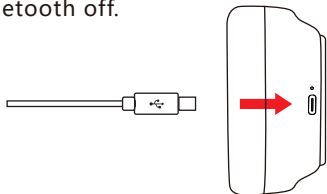

If any issues, here tips for you: 1. Full charge your headphone (don't use fast charger) 2. Reset headphone by inserting audio cable into headphone audio socket then removing it. Or the upgraded NC 35 headphones would be reset automatically when charging.

Delete Pairing: Turn off the headphone first, then Long press the "Multi-function" button for 8 seconds. You will hear "Power on" ; " Connected" ; " Disconnected" ; " Pairing" voice prompts subsequently

Q&A

1. Q: Why can't headphone pair with my mobile phone?

A: Please check if your headphone is in pairing mode or re-connection mode, check if Bluetooth search function of your BT device is turned on, if all done, then go to Bluetooth menu of your Bluetooth device, delete/ignore the headphone Bluetooth pairing name " T-fun NC35". After that, you can try to reconnect Bluetooth according to above "Easy Pairing" steps.

2. Q: Why can't headphone turn on?

A: Please double check the battery status of your headphone.

3. Q: Can I replace battery in the headphone?

A: No, you can not. Headphone uses a built-in non-detachable Li-Polymer battery that can't be replaced.

4. Q: Can I use headphone while driving?

A: For your safety, we strongly recommend that you do not use headphone while driving to avoid distraction.

5. Q: Why does headphone sometimes disconnects with Bluetooth device within 10 meters?

A: Please check if there are any metal materials or obstacles within a relatively close range or your surroundings that perhaps interfering with Bluetooth connection. This may happen because Bluetooth is a radio technology which is sensitive to objects between headphone and other devices.

6. Q: Why can't I hear any sound from my computer or mobile phone?

A: Please check if output channel of your computer supports A2DP profile. Also check the volume settings on your headphone and computer/mobile phone.

7. Q: Why am I unable to use headphone to control the volume of a track playing on an APP on my mobile phone?

A: Due to configurations of different application software, headphone may not be completely compatible with some APPs.

8. Q: What do I do if Bluetooth can not close or open?

A: Please reset Bluetooth function of headphone by inserting an audio cable into headphone audio port, then removing it. Before re-connecting, kindly remember to delete/ignore headphone Bluetooth pairing name "T-fun NC35" on your mobile phone.

9. Q: Why does Bluetooth turn off when I connect an audio cable?

A: This is one of our special features. When users insert an audio cable into headphone audio port, all Bluetooth feature buttons stop working and Bluetooth turns off. But, Bluetooth will be available again when audio cable is moved.

10. Q: Why can't I turn headphone on/off?

A: Please note that ANC and Bluetooth are indicated by the same LED indicator light (but different light color), with a green light for ANC and a blue light for Bluetooth. If you need to turn Bluetooth on/off, you can turn off ANC firstly in case that you are confused by the color lights. But you will be very familiar with the light color meaning after using a few times because it is simple and easy.

11. Q: Why does audio quality become poor on Windows PC?

A: Some customers have mentioned poor audio quality on Windows PC. Please note that there are "Headset" and "Headphone" modes you can toggle by changing your output device. Selecting "Headphone Mode" will drastically improve the audio quality. "Headset Mode" is designed for highly compressed VOIP calls, etc. That's not the fault of the headphone product, that's just the limitation of that protocol. If you are in "Headphone Mode", the audio quality is fantastic.

FCC Caution:

Any Changes or modifications not expressly approved by the party responsible for compliance could void the user's authority to operate the equipment.

This device complies with part 15 of the FCC Rules. Operation is subject to the following two conditions: (1) This device may not cause harmful interference, and (2) this device must accept any interference received, including interference that may cause undesired operation.

IMPORTANT NOTE:

NOTE: This equipment has been tested and found to comply with the limits for a Class B digital device, pursuant to part 15 of the FCC Rules. These limits are designed to provide reasonable protection against harmful interference in a residential installation. This equipment generates, uses and can radiate radio frequency energy and, if not installed and used in accordance with the instructions, may cause harmful interference to radio communications. However, there is no guarantee that interference will not occur in a particular installation. If this equipment does cause harmful interference to radio or television reception, which can be determined by turning the equipment off and on, the user is encouraged to try to correct the interference by one or more of the following measures:

- Reorient or relocate the receiving antenna.
- Increase the separation between the equipment and receiver.
- Connect the equipment into an outlet on a circuit different from that to which the receiver is connected.
- Consult the dealer or an experienced radio/TV technician for help.

FCC Radiation Exposure Statement:

This equipment complies with FCC radiation exposure limits set forth for an uncontrolled environment .

ISED warning

This device complies with Innovation, Science, and Economic Development Canada license-exempt RSS standard(s). Operation is subject to the following two conditions: (1) this device may not cause interference, and (2) this device must accept any interference, including interference that may cause undesired operation of the device.

Le présent appareil est conforme aux CNR d' Innovation, Sciences et Développement économique Canada applicables aux appareils radio exempts de licence. L'exploitation est autorisée aux deux conditions suivantes :
(1) l'appareil ne doit pas produire de brouillage, et
(2) l'utilisateur de l'appareil doit accepter tout brouillage radioélectrique subi, même si le brouillage est susceptible d'en compromettre le fonctionnement.

The device is compliance with RF exposure guidelines, users can obtain Canadian information on RF exposure and compliance. The distance from body to use the device is < 5mm.

Le présent appareil est conforme
Après examen de ce matériel aux conformité ou aux limites d' intensité de champ RF,
les utilisateurs peuvent sur l' exposition aux radiofréquences et la conformité and compliance d' acquérir les informations correspondantes. La distance minimale du corps à utiliser le dispositif est de 5mm.